



PLEASE READ BEFORE USE!

INSTALLATION GUIDE ABD16/CCT/COR (CORRIDOR SENSOR)

⚠ ENSURE POWER SUPPLY IS OFF WHEN HANDLING ANY ELECTRICAL EQUIPMENT.

- This product may need to be installed by a qualified electrical installer.
- Please read this guide in its entirety to fully understand the products before attempting any install.
- All electrical work should be completed in accordance with the latest IET regulations, and/or any other relevant rules, regulations or laws of the country in which it is being installed.
- The item must be installed in isolation from any insulating material and is adequately ventilated to prevent premature failure.
- Ensure power supply is isolated prior to installation, maintenance or performing any other form of electrical work.
- In the event of incorrect or improper function with specific regard to any of All LED's products contact All LED for further advice.

SAFETY WARNING

- ENSURE THE PROTECTIVE PLASTIC PLATE LOCATED ON TOP OF THE LEDS IS NEVER REMOVED OR TAMPERED WITH.
- IF THERE IS ANY VISIBLE DAMAGE TO THIS ITEM, PLEASE ENSURE THAT THE POWER IS SWITCHED OFF AND REMAINS OFF.
- DO NOT TOUCH THE LED CHIPS AT ANY POINT DURING, OR AFTER INSTALLATION OF THE LUMINAIRE AS THERE IS RISK OF ELECTRICAL SHOCK.

Technical Specifications

Product Code	ABD16/CCT/COR		
Luminous Flux (LM)	2130	2320	2270
Useful Luminous Flux (LM)	2130	2320	2270
CCT (Kelvin)	3000K	4000K	6000K
Peak Intensity	673	742	726
CRI		>80	
Beam Angle (°)		115°	
Operating Voltage (Vac)	220-240Vac		
Operating Current (A max)	0.092A		
Max Output Power	16W		
Power Factor (Pf)	0.79		
No Load Power (W)	≤0.5W		
Efficiency %	94%		
Driver Max Output Current (mA)	180mA		
Driver Max Output Voltage (Vdc)	89Vdc		
Class	II		
Body Material	Polycarbonate		
Frame Colour	White		
Switching Cycles	50,000		
Ingress Protection	IP65		
Ambient Operating Temperature (°C)	-20°C~45°C		
Input Frequency (Hz)	50/60Hz		
Guarantee	5 Years		
Lifetime (L70 B50)	50,000H		
IK Rating	IK10		
Displacement Factor	≥0.7		
Flicker Metric (PstLM)	≤1.0		
Stroboscopic Effect Metric (SVM)	≤0.4		
Energy Rating	E		

Corridor Sensor	
Detection Range	50%, 100% (4-10M)
Hold Time	5s, 90s, 3min, 10min
Daylight Sensor	10Lux or Disable

Installation

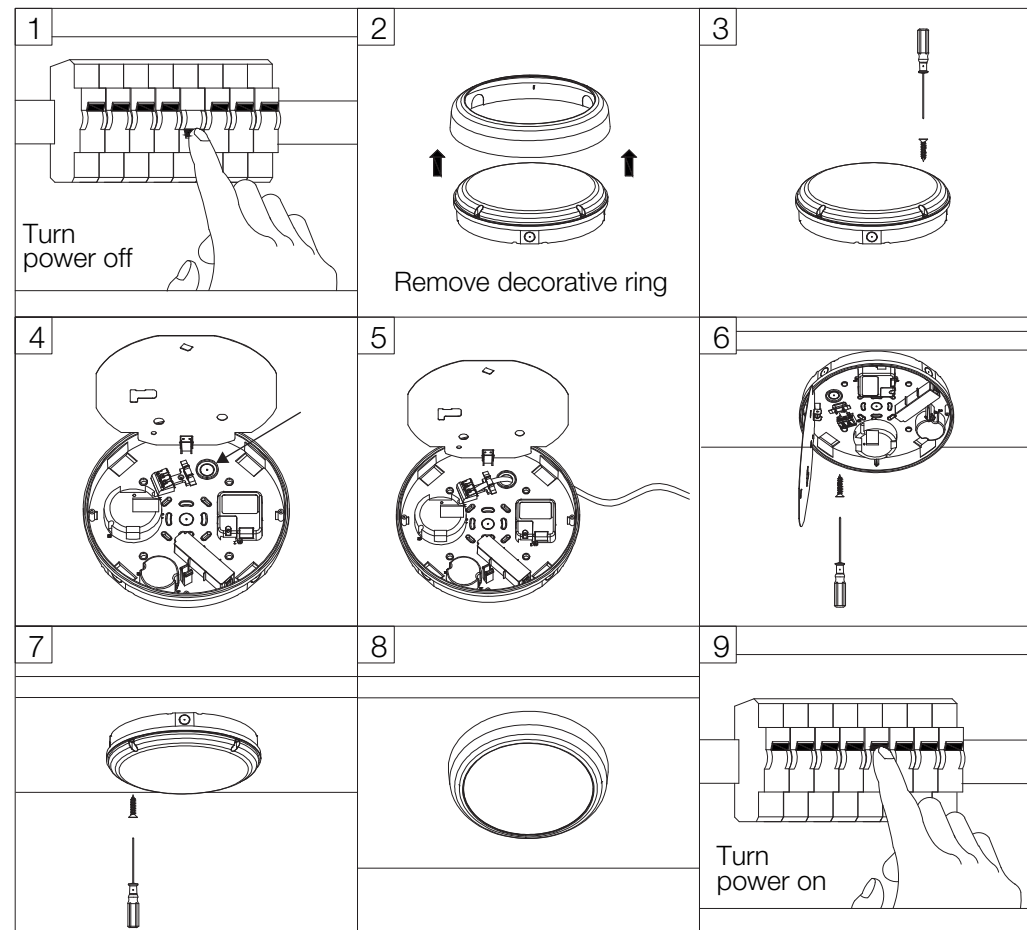

Dimensions

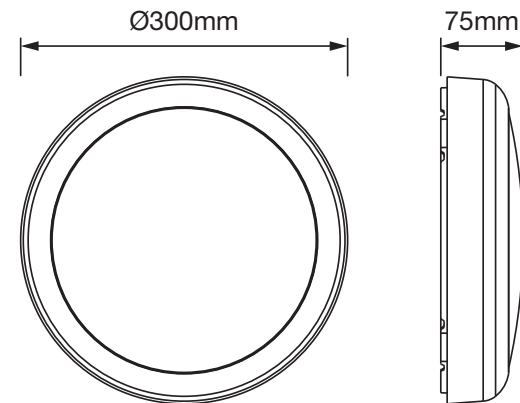

Sensor Setup

1. Sensitivity

Sensitivity can be adjusted by selecting the combination on the DIP switches for different applications.

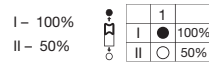

2. Hold-time

Hold-time refers to the time period that the light remains 100% on if no more movement is detected.

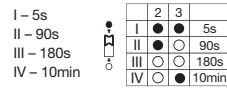

3. Daylight threshold

Different lux levels can be preset on DIP switches. Luminaire will always turn on upon movement if daylight sensor is disabled.

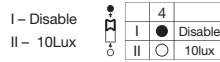

4. Stand-by time

This is the time period that the light remains at a low level before it is completely turned off.

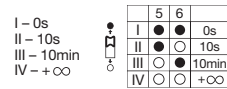

5. Stand-by dimming level

Light can be dimmed to different levels after hold-time.

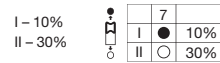

Notes

This product contains a light source of energy efficiency class: E. The light source contained in this luminaire shall only be replaced by the manufacturer or his service agent or a similar qualified person.

Troubleshooting Guide

PROBLEM	CAUSE(S)	SOLUTION(S)
No Light Output From LEDs	No power to drive components	A qualified installer/electrician should check the primary voltage side of the product to check the input voltage.
	Loose connection on circuit	Ensure continuous and correct connection between terminals.
	Overvoltage may have caused damage to the sensitive components	These cases are rare and the item may need replacement and/or investigation as to the cause of failure.
LEDs Flashing	Incorrect voltage range being used	Please ensure there is a regulated AC voltage supply within the parameters of the luminaire. Failure to do so will void the warranty.
	LED driver may be connected to a mains dimmer switch	Please remove the dimmer switch and wire the unit to a switch, removing any mains dimmers or other dimmers on the primary side. Use of this product on a dimmer will void the warranty.
	Loose connection on circuit.	Ensure continuous and correct connection between the terminals.



ATTENTION

IF ANY PROBLEMS PERSIST, PLEASE CALL THE ALL LED TECHNICAL DEPARTMENT FOR FURTHER ASSISTANCE.

Safety

- Do not cover the ground contact.
- Do not cover the luminaire, hang or fasten anything from it.
- Do not operate if any visible damage can be seen to the product.
- Do not operate if any water ingress has occurred.
- Do not operate if any smoke, steam or crackling noises can be heard from the luminaire.
- Do not operate if any signs of overheating are recognised.
- Avoid installation in any areas where there is a risk of strong mechanical loads.
- Do not place any material over the lens or LED diode/chip.
- Do not insert objects into the luminaire.
- Do not clean using any solvent based abrasive or aggressive products.
- Do not pull any cables connected to the product.
- Do not direct the luminaire into a person's eyes, as this unit may have an intense light output, which if incorrectly used may cause eye damage.
- Light engines/LEDs and other light sources may heat up, please take care when handling the products.
- The manufacturer will not be deemed liable or held responsible for any damages caused by faults or manufacturing defects that may be present in any of its products or the misuse or incorrect installation of this device. Please refer to our troubleshooting guide for further information.
- The manufacturer will not be held liable for any death(s) or injuries caused by misuse or poor installation or any unreported faults of this product version or versions thereof.
- LEDs are sensitive to electrostatic discharge. Do not touch the surface of the LED module.
- Do not connect to a temporary electricity supply, this may damage the electronics.
- Light fittings with an integrated emergency option come with a separate installation and wiring leaflet. Please refer to this manual for further details. If the manual is unavailable please contact an ALL LED representative for assistance.
- It is strongly recommended that a Residual-Current Device (RCD) is used with this product to minimise the risk of electrocution.
- REPLACE DAMAGED PRODUCT IMMEDIATELY.
- Keep away from children.

Returns & Faulty Items

- If any problems are encountered during or after installation, please call the All LED technical department to get the problem resolved as soon as possible.
- Please do not just return the item to the outlet you purchased it from, as you are only entitled to a replacement or refund after the unit has undergone testing and the unit has been confirmed as having a manufacturing defect/fault. Your statutory rights are not affected.
- The manufacturer will not be deemed liable or held responsible for any damages caused by faults or manufacturing defects that may be present in any of its products or the misuse or incorrect installation of this device. Please refer to our troubleshooting guide for further information.
- All installations must be carried out in accordance with this installation guide and user manual.
- All goods are supplied under the terms and conditions of All LED LTD, a copy of which may be obtained upon written request.

Environmental Protection
Waste electrical products should not be disposed of with household waste. Please recycle where facilities exist. Check with your Local Authority or retailer for recycling advice



ISOLATE MAINS SUPPLY BEFORE HANDLING ANY ELECTRICAL PRODUCTS



The manufacturer will not be deemed liable or held responsible for any damages caused by faults or manufacturing defects that may be present in any of its products or the misuse or incorrect installation of this device
Your statutory rights are not affected.



ALL LED LTD
42 Sedgwick Road,
Luton, LU4 9DT

www.allledgroup.com
sales@allledgroup.com
Tel: +44 (0)208 841 9000

